

Close to you.

MANUFACTURER SINCE 1921

Screwdriver set for the dental laboratory

Consisting of various inserts for the most common implant systems

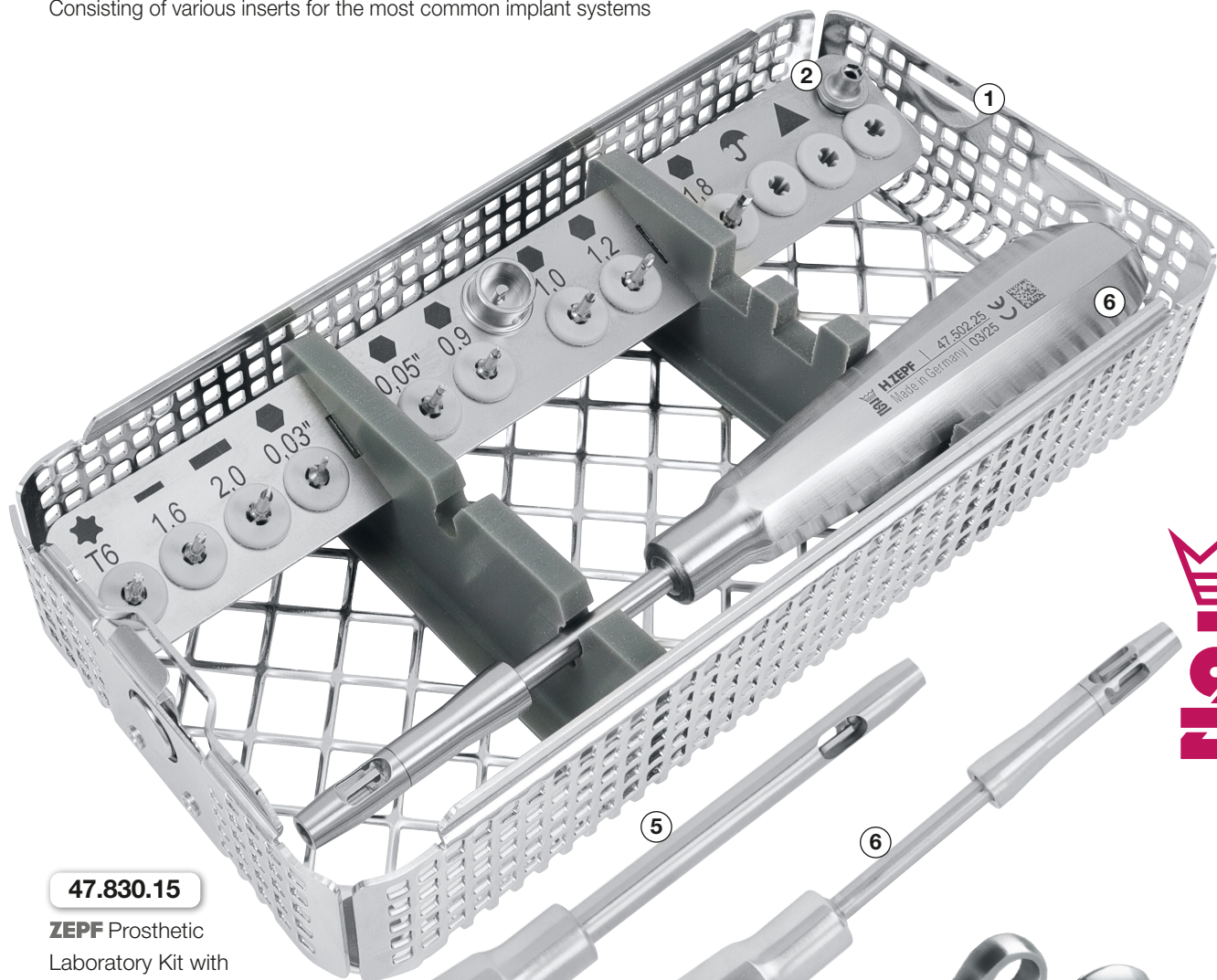

47.830.15

ZEPF Prosthetic
Laboratory Kit with
optional screwdriver



47.502.15

Universal Handle for
the Prosthetic Kit,
16 cm, optional

47.502.25

Cardan-Screwdriver,
16 cm, optional

47.803.02

Torque Wrench,
optional

47.525.55

Ratchet with demountable handle
for Prosthetic Kit, optional

ZEPF dental
newsticker









Screwdriver set for the dental laboratory

Are you confronted with loosening all types of implant abutments on a daily basis in the practice/laboratory? To make your work easier, Zepf has created a prosthetics set for you with which you can loosen approx. 90% of all screws on the market.

All instruments are numbered and have an RA-HEX connection. This means that these instruments can be used both in the contra-angle handpiece and in a ratchet. The finger ratchet can optionally be used with an extension. A torque ratchet can also be added to the set. This is adjustable from 10 - 40 Ncm. It also includes a locking function to deactivate the torque.

A universal handle and the cardan screwdriver handle are also optionally available to supplement the set for user-friendly use. The stainless steel storage tray contains the description of the individual screwdrivers, making it easy to identify the tools for the respective screw. The tray is stored in a washing basket and can therefore be reliably fed into the reprocessing process, thus fulfilling optimum reprocessing in accordance with RKI criteria.

47.830.15 Complete **ZEPF** Prosthetic Laboratory Kit consisting of:

Shape	Screwdrivers with dental lock	short, 21 mm
	TORX T6, Straumann®, Aesthura®	47.832.01
	Universal flat 1.6 mm, narrow	47.832.02
	Universal flat 1.6 mm, wide	47.832.03
	Allen Key SW HEX 0,03'', Camlog®	47.832.04
	Allen Key SW HEX 0,05'', Camlog®, Sulzer® (Zimmer®), Semados®, Biomet 3I®	47.832.05
	Allen Key SW 0,9 mm, IMPLA®, TIOLOX®, BREDDENT®, XIVE®	47.832.06
	Allen Key SW 1,0 mm, Ankylos®	47.832.07
	Allen Key SW 1,2 mm, IMPLA®, Nobel Biocare®, Frialit®, XIVE®, IMZ®, Biomet 3I®	47.832.08
	Allen Key SW 1,8 mm, Ankylos®	47.832.09
1	1/3 Washbasket with Lid	85.192.45
2	Driver Guide	47.525.51
3	Optional Accessory: Ratchet with demountable handle for Prosthetic Kit (not included in the set)	47.525.55
4	Optional Accessory: Torque Wrench (not included in the set)	47.803.02
5	Optional Accessory: Universal Handle for the Prosthetic Kit, 16 cm (not included in the set)	47.502.15
6	Optional Accessory: Cardan-Screwdriver in Flohrhandle (not included in the set)	47.502.25

ALL THE TRADEMARKS ARE THE PROPERTY OF THE RESPECTIVE COMPANIES.
We assume no liability for deviations due to tolerances of implants.



In the RA-Hex-Adapter the inserts will be picked up.



RA-Hex Adapter inserted in ratchet. Shown with demounted handle for use as finger ratchet. Information: The RA-Hex-Adapter has a rotating finger rest available (see red arrow).



Cardan-Screwdriver with FD-HEX-dental connection; for universal pickup of bits with FD- or FD-HEX connection for optimal power transmission.

